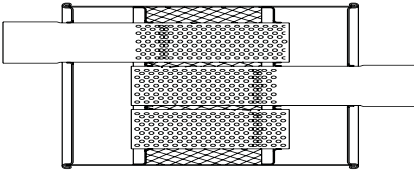
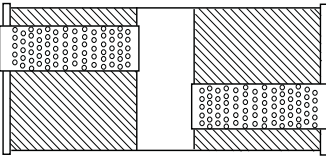
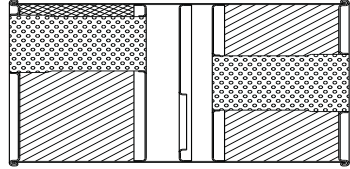
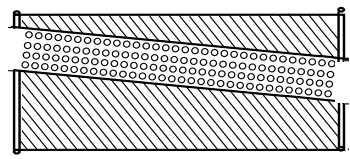

Offset / Centre

Diagram	In/Out	Length	Case	Part
	38mm 38mm	250mm	200 x 100	VL26ØOCX
	44mm 44mm	350mm	220 x 120	VQ35ØOCY
		400mm	220 x 120	VQ40ØOCY
	51mm 51mm	350mm	200 x 100	VL3ØØOCZ
		400mm	200 x 100	VL4ØØOCZ
		400mm	220 x 120	VQ4ØØOCZ
	44mm 44mm	350mm	200 x 100	VL357OCY
	51mm 51mm	350mm	200 x 100	VL357OCZ
<p><i>Internal resonator, ideal for DOHC & VTec engines.</i></p>	41mm 41mm	350mm	220 x 120	VQ347OCV
	44mm 44mm	400mm	200 x 100	VL4Ø9OCY
	51mm 51mm	400mm	220 x 120	VQ419OCZ
<p>51mm internals</p>	57mm 57mm	400mm	250 x 100	V K Ø 5 6 8
	47mm 47mm	400mm	300 x 150	V J Ø Ø 9 8
	51mm 51mm	400mm	300 x 150	V J Ø 4 8 1
	63mm 63mm	275mm	250 x 100	V K 1 Ø 5 6
		350mm	250 x 100	V K 1 4 3 2

**For any part not listed please call our sales office
PH 0800 288 623**

Offset / Centre

Diagram	In/Out	Length	Case	Part
	51mm 51mm	350mm	250 x 100	V K Ø 9 5 1
	57mm 57mm	350mm	250 x 100	V K 1 Ø 5 2
		400mm	250 x 100	V K Ø 7 9 1
	63mm 63mm	350mm	250 x 100	V K Ø 7 9 3
		400mm	250 x 100	V K 1 Ø 8 6
		51mm 51mm	400mm	200 x 100
63mm 63mm		350mm	200 x 100	VL 3 5 7 R J
	76mm 76mm	350mm	220 x 120	VQ367RKE
	57mm 57mm	350mm	200 x 100	VL 3 5 7 RH
	63mm 63mm	350mm	250 x 100	V K 3 6 7 R J
		350mm	220 x 120	V Q 3 6 7 R J
		450mm	200 x 100	VL 4 5 Ø R J
	76mm 76mm	350mm	220 x 120	V Q 3 6 7 R K

Offset / Offset

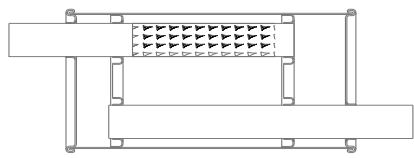
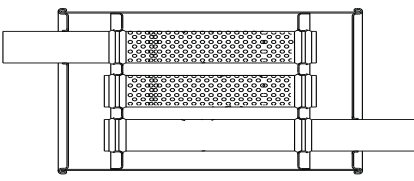
Diagram	In/Out	Length	Case	Part
				
	38mm 38mm	300mm	175 x 85	VM3ØØ00V
	44mm 44mm	400mm	220 x 120	VQ35Ø00Y
		400mm	220 x 120	VQ4ØØ00Y
	51mm 51mm	350mm	200 x 100	VL3ØØ00Z
	51mm 51mm	400mm	200 x 100	VL4ØØ00Z
		400mm	220 x 120	VQ4ØØ00Z

For any part not listed please call our sales office

Offset / Offset

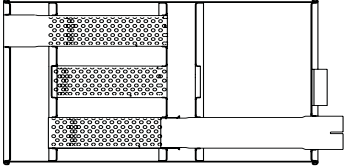
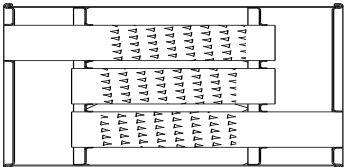
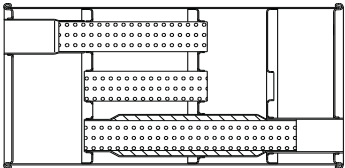
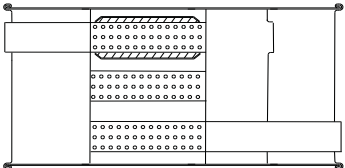
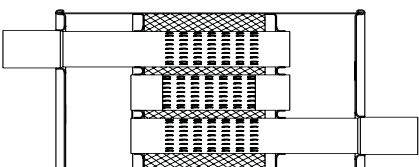
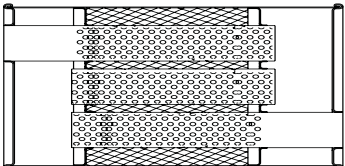
Diagram	In/Out	Length	Case	Part
 <p><i>Triple flow - "I" beam design</i></p>	76mm 76mm	350mm	220 x 120	VQ36700K
 <p><i>Outlet stub & Falcon mount on rear plate</i></p>	51mm 51mm	500mm	300 x 100	V K 1 2 5 2
	57mm 57mm	500mm	300 x 100	V K 1 2 1 8
	44mm 44mm	350mm	200 x 100	VL35700Y
	51mm 51mm	350mm	200 x 100	VL35700Z
	57mm 57mm	400mm	250 x 100	V K Ø 5 7 Ø
 <p><i>Internal resonator, ideal for DOHC & VTec engines</i></p>	41mm 41mm	350mm	220 x 120	VQ34700V
	44mm 44mm	400mm	200 x 100	VL40900Y
	51mm 51mm	400mm	220 x 120	VQ41900Z
	47mm 47mm	400mm	300 x 150	V J Ø Ø 9 9
	51mm 51mm	350mm	250 x 100	V K Ø 9 5 Ø
	57mm 57mm	350mm	250 x 100	V K Ø 7 9 Ø
	63mm 63mm	350mm	250 x 100	V K Ø 7 9 2
		400mm	250 x 100	V K 1 Ø 8 4
	63mm 63mm	350mm	250 x 100	V K 1 4 3 1

**For any part not listed please call our sales office
PH 0800 288 623**

Offset / Offset

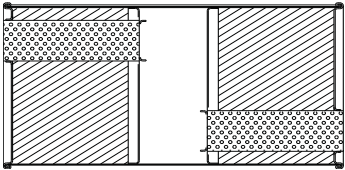
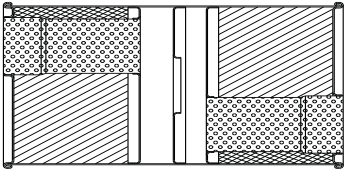
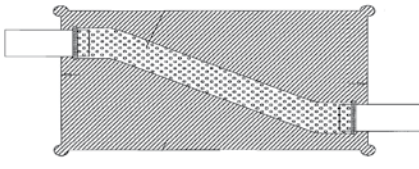
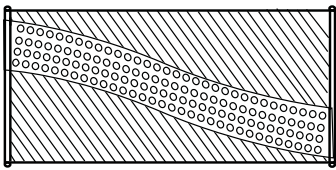
Diagram	In/Out	Length	Case	Part
	51mm 51mm	400mm	200 x 100	VL4Ø7QA
	76mm 76mm	350mm	220 x 120	VQ367QKE
	38mm 38mm	350mm	200 x 100	VL35ØQX
	63mm 63mm	450mm	200 x 100	VL45ØQJ
	57mm 57mm	350mm	200 x 100	VL357QH
	63mm 63mm	350mm	250 x 100	VK367QJ
		350mm	220 x 120	VQ367QJ
		400mm	200 x 100	VL4Ø7QJ
	76mm 76mm	400mm	220 x 120	VQ367QK

Centre / Centre

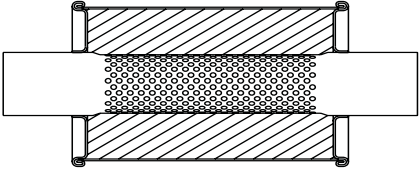
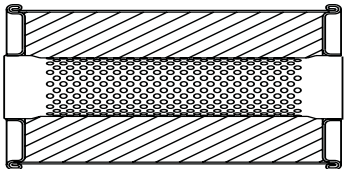
Diagram	In/Out	Length	Case	Part
	44mm 44mm	250mm	125 x 75	VS25ØYY
		350mm	125 x 75	VS35ØYY
		450mm	125 x 75	VS45ØYY
	51mm 51mm	250mm	125 x 75	VS25ØZZ
		350mm	125 x 75	VS45ØZZ
	57mm 57mm	250mm	175 x 85	VM25ØHH
	44mm 44mm	250mm	125 x 75	VS257YY
	47mm 47mm	300mm	175 x 85	VM3Ø7WW
	51mm 51mm	250mm	125 x 75	VS257ZZ
	57mm 57mm	350mm	200 x 100	VL357SH
	63mm 63mm	350mm	220 x 120	VQ367SJ

For any part not listed please call our sales office

Centre / Centre

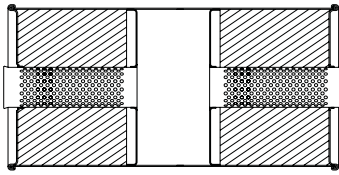
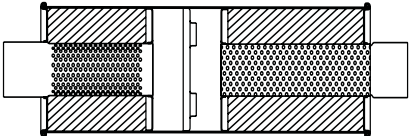
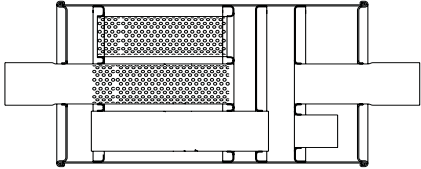
Diagram	In/Out	Length	Case	Part
	51mm 51mm	400mm	200 x 100	VL4Ø7SA
	44mm 44mm	400mm	175 x 85	VM4ØØSYE
	51mm 51mm	400mm	200 x 100	VL4ØØNA

Offset Same Side

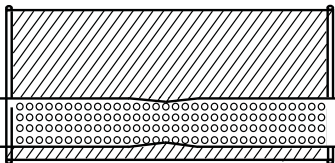
	47mm 47mm	250mm	200 x 100	VL275ØYY
	63mm 63mm	250mm	200 x 100	VL2670JJ
	76mm 76mm	250mm	220 x 120	VQ2670KK

Same End In / Out

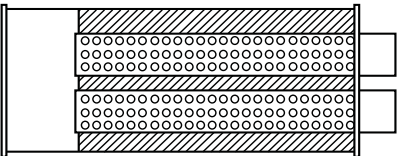
	51mm 51mm	400mm	220 x 120	VQ8935

Single In / Dual Out

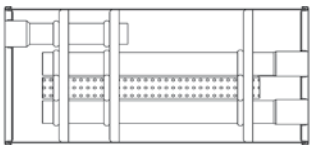
	44mm^{38/38}	350mm	220 x 120	VQØ482
	51mm^{41/41}	400mm	300 x 150	VJØ66Ø
	51mm^{44/44}	400mm	300 x 150	VJ1Ø19
<small>VQ0482 - LH In/RH Out, VJ0660 RH In/LH Out, VJ1019 Centre In/Out</small>				

For any part not listed please call our sales office

PH 0800 288 623

Dual In / Dual Out

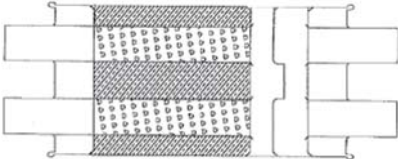
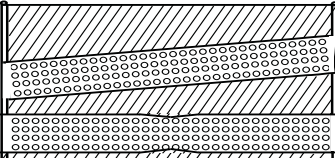
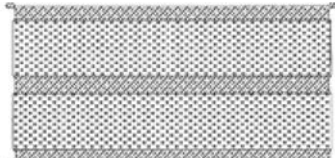
Diagram	In/Out	Length	Case	Part
	51 51 / 51	400mm	200 x 100	VL4ØØTZ
	57 57 / 57	500mm	300 x 115	VK1195
	76 76 / 76	350mm	220 x 120	VQ357TK

For any part not listed please call our sales office